

NPN Silicon AF Transistors

- For AF input stages and driver applications
- High current gain
- Low collector-emitter saturation voltage
- Low noise between 30 Hz and 15 kHz
- Complementary types:
BC857...-BC860...(PNP)
- Pb-free (RoHS compliant) package
- Qualified according AEC Q101¹⁾



¹⁾BC847BL3 is not qualified according AEC Q101

Type	Marking	Pin Configuration						Package
BC847A	1Es	1=B	2=E	3=C	-	-	-	SOT23
BC847B	1Fs	1=B	2=E	3=C	-	-	-	SOT23
BC847BL3*	1F	1=B	2=E	3=C	-	-	-	TSLP-3-1
BC847BW	1Fs	1=B	2=E	3=C	-	-	-	SOT323
BC847C	1Gs	1=B	2=E	3=C	-	-	-	SOT23
BC847CW	1Gs	1=B	2=E	3=C	-	-	-	SOT323
BC848A	1Js	1=B	2=E	3=C	-	-	-	SOT23
BC848B	1Ks	1=B	2=E	3=C	-	-	-	SOT23
BC848BL3	1K	1=B	2=E	3=C	-	-	-	TSLP-3-1
BC848BW	1Ks	1=B	2=E	3=C	-	-	-	SOT323
BC848C	1Ls	1=B	2=E	3=C	-	-	-	SOT23
BC848CW	1Ls	1=B	2=E	3=C	-	-	-	SOT323
BC849B	2Bs	1=B	2=E	3=C	-	-	-	SOT23
BC849C	2Cs	1=B	2=E	3=C	-	-	-	SOT23
BC849CW	2Cs	1=B	2=E	3=C	-	-	-	SOT323
BC850B	2Fs	1=B	2=E	3=C	-	-	-	SOT23
BC850BW	2Fs	1=B	2=E	3=C	-	-	-	SOT323
BC850C	2Gs	1=B	2=E	3=C	-	-	-	SOT23
BC850CW	2Gs	1=B	2=E	3=C	-	-	-	SOT323

* Not qualified according AEC Q101

Maximum Ratings

Parameter	Symbol	Value	Unit
Collector-emitter voltage BC847..., BC850... BC848..., BC849...	V_{CEO}	45 30	V
Collector-emitter voltage BC847..., BC850... BC848..., BC849...	V_{CES}	50 30	
Collector-base voltage BC847..., BC850... BC848..., BC849...	V_{CBO}	50 30	
Emitter-base voltage BC847..., BC850... BC848..., BC849...	V_{EBO}	6 6	
Collector current	I_C	100	mA
Peak collector current, $t_p \leq 10$ ms	I_{CM}	200	
Total power dissipation- $T_S \leq 71$ °C, BC847-BC850 $T_S \leq 135$ °C, BC847BL3-BC848BL3 $T_S \leq 124$ °C, BC847W-BC850W	P_{tot}	330 250 250	mW
Junction temperature	T_j	150	°C
Storage temperature	T_{stg}	-65 ... 150	

Thermal Resistance

Parameter	Symbol	Value	Unit
Junction - soldering point ¹⁾ BC847-BC850 BC847BL3-BC848BL3 BC847W-BC850W	R_{thJS}	≤ 240 ≤ 60 ≤ 105	K/W

¹For calculation of R_{thJA} please refer to Application Note AN077 (Thermal Resistance Calculation)

Electrical Characteristics at $T_A = 25^\circ\text{C}$, unless otherwise specified

Parameter	Symbol	Values			Unit
		min.	typ.	max.	
DC Characteristics					
Collector-emitter breakdown voltage $I_C = 10\text{ mA}$, $I_B = 0$, BC847..., BC850... $I_C = 10\text{ mA}$, $I_B = 0$, BC848..., BC849...	$V_{(BR)CEO}$	45 30	- -	- -	V
Collector-base breakdown voltage $I_C = 10\text{ }\mu\text{A}$, $I_E = 0$, BC847..., BC850... $I_C = 10\text{ }\mu\text{A}$, $I_E = 0$, BC848..., BC849...	$V_{(BR)CBO}$	50 30	- -	- -	
Emitter-base breakdown voltage $I_E = 0$, $I_C = 10\text{ }\mu\text{A}$	$V_{(BR)EBO}$	-	6	-	
Collector-base cutoff current $V_{CB} = 45\text{ V}$, $I_E = 0$ $V_{CB} = 30\text{ V}$, $I_E = 0$, $T_A = 150\text{ }^\circ\text{C}$	I_{CBO}	- -	0.015 5	- -	μA
DC current gain ¹⁾ $I_C = 10\text{ }\mu\text{A}$, $V_{CE} = 5\text{ V}$, h_{FE} -grp.A $I_C = 10\text{ }\mu\text{A}$, $V_{CE} = 5\text{ V}$, h_{FE} -grp.B $I_C = 10\text{ }\mu\text{A}$, $V_{CE} = 5\text{ V}$, h_{FE} -grp.C $I_C = 2\text{ mA}$, $V_{CE} = 5\text{ V}$, h_{FE} -grp.A $I_C = 2\text{ mA}$, $V_{CE} = 5\text{ V}$, h_{FE} -grp.B $I_C = 2\text{ mA}$, $V_{CE} = 5\text{ V}$, h_{FE} -grp.C	h_{FE}	- - - 110 200 420	140 250 480 180 290 520	- - - 220 450 800	-
Collector-emitter saturation voltage ¹⁾ $I_C = 10\text{ mA}$, $I_B = 0.5\text{ mA}$ $I_C = 100\text{ mA}$, $I_B = 5\text{ mA}$	V_{CEsat}	- -	90 200	250 600	mV
Base emitter saturation voltage ¹⁾ $I_C = 10\text{ mA}$, $I_B = 0.5\text{ mA}$ $I_C = 100\text{ mA}$, $I_B = 5\text{ mA}$	V_{BEsat}	- -	700 900	- -	
Base-emitter voltage ¹⁾ $I_C = 2\text{ mA}$, $V_{CE} = 5\text{ V}$ $I_C = 10\text{ mA}$, $V_{CE} = 5\text{ V}$	$V_{BE(ON)}$	580 -	660 -	700 770	

¹⁾Pulse test: $t < 300\mu\text{s}$; $D < 2\%$

Electrical Characteristics at $T_A = 25^\circ\text{C}$, unless otherwise specified

Parameter	Symbol	Values			Unit
		min.	typ.	max.	
AC Characteristics					
Transition frequency $I_C = 10\text{ mA}, V_{CE} = 5\text{ V}, f = 100\text{ MHz}$	f_T	-	250	-	MHz
Collector-base capacitance $V_{CB} = 10\text{ V}, f = 1\text{ MHz}$	C_{cb}	-	0.95	-	pF
Emitter-base capacitance $V_{EB} = 0.5\text{ V}, f = 1\text{ MHz}$	C_{eb}	-	9	-	
Short-circuit input impedance $I_C = 2\text{ mA}, V_{CE} = 5\text{ V}, f = 1\text{ kHz}, h_{FE}\text{-grp.A}$ $I_C = 2\text{ mA}, V_{CE} = 5\text{ V}, f = 1\text{ kHz}, h_{FE}\text{-grp.B}$ $I_C = 2\text{ mA}, V_{CE} = 5\text{ V}, f = 1\text{ kHz}, h_{FE}\text{-grp.C}$	h_{11e}	-	2.7 4.5 8.7	-	k Ω
Open-circuit reverse voltage transf. ratio $I_C = 2\text{ mA}, V_{CE} = 5\text{ V}, f = 1\text{ kHz}, h_{FE}\text{-grp.A}$ $I_C = 2\text{ mA}, V_{CE} = 5\text{ V}, f = 1\text{ kHz}, h_{FE}\text{-grp.B}$ $I_C = 2\text{ mA}, V_{CE} = 5\text{ V}, f = 1\text{ kHz}, h_{FE}\text{-grp.C}$	h_{12e}	-	1.5 2 3	-	
Short-circuit forward current transf. ratio $I_C = 2\text{ mA}, V_{CE} = 5\text{ V}, f = 1\text{ kHz}, h_{FE}\text{-grp.A}$ $I_C = 2\text{ mA}, V_{CE} = 5\text{ V}, f = 1\text{ kHz}, h_{FE}\text{-grp.B}$ $I_C = 2\text{ mA}, V_{CE} = 5\text{ V}, f = 1\text{ kHz}, h_{FE}\text{-grp.C}$	h_{21e}	-	200 330 600	-	
Open-circuit output admittance $I_C = 2\text{ mA}, V_{CE} = 5\text{ V}, f = 1\text{ kHz}, h_{FE}\text{-grp.A}$ $I_C = 2\text{ mA}, V_{CE} = 5\text{ V}, f = 1\text{ kHz}, h_{FE}\text{-grp.B}$ $I_C = 2\text{ mA}, V_{CE} = 5\text{ V}, f = 1\text{ kHz}, h_{FE}\text{-grp.C}$	h_{22e}	-	18 30 60	-	μS
Noise figure $I_C = 200\text{ }\mu\text{A}, V_{CE} = 5\text{ V}, f = 1\text{ kHz},$ $\Delta f = 200\text{ Hz}, R_S = 2\text{ k}\Omega, \text{BC849...}, \text{BC850...}$	F	-	1.2	4	dB
Equivalent noise voltage $I_C = 200\text{ }\mu\text{A}, V_{CE} = 5\text{ V}, R_S = 2\text{ k}\Omega,$ $f = 10 \dots 50\text{ Hz}, \text{BC850...}$	V_n	-	-	0.135	μV

DC current gain $h_{FE} = f(I_C)$

$V_{CE} = 5\text{ V}$

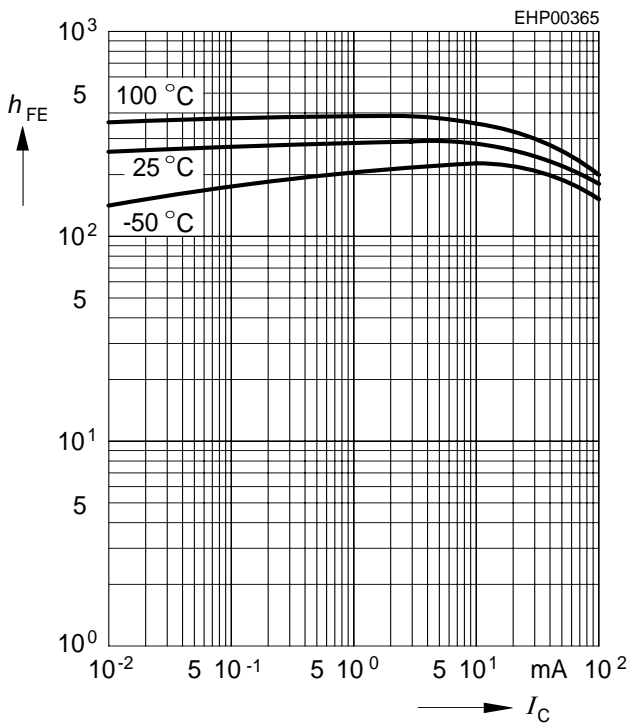

Collector-emitter saturation voltage

$I_C = f(V_{CEsat}), h_{FE} = 20$

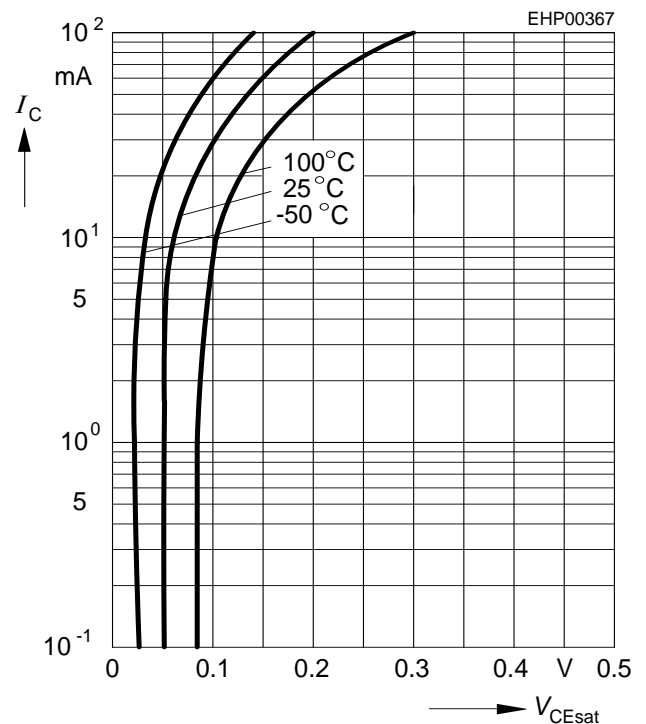

Base-emitter saturation voltage

$I_C = f(V_{BEsat}), h_{FE} = 20$



Collector cutoff current $I_{CBO} = f(T_A)$

$V_{CB} = 30\text{ V}$

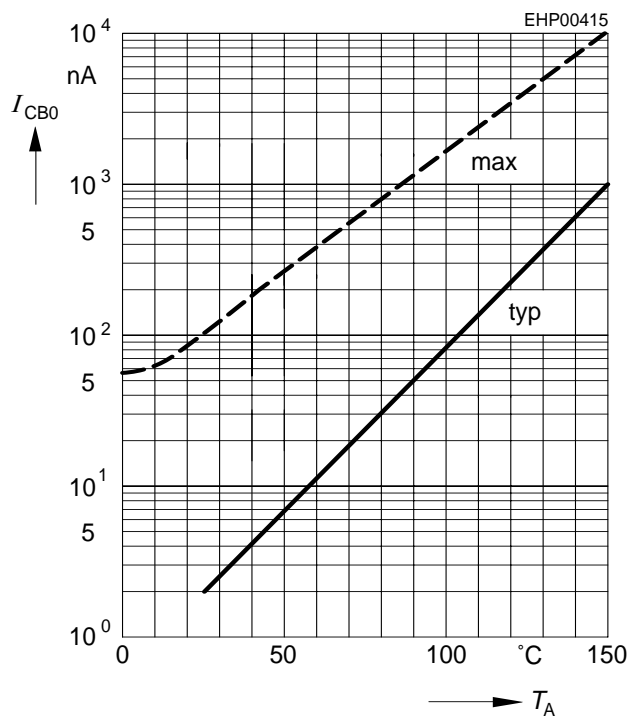

Transition frequency $f_T = f(I_C)$

$V_{CE} = 5\text{ V}$



Collector-base capacitance $C_{cb} = f(V_{CB})$

Emitter-base capacitance $C_{eb} = f(V_{EB})$

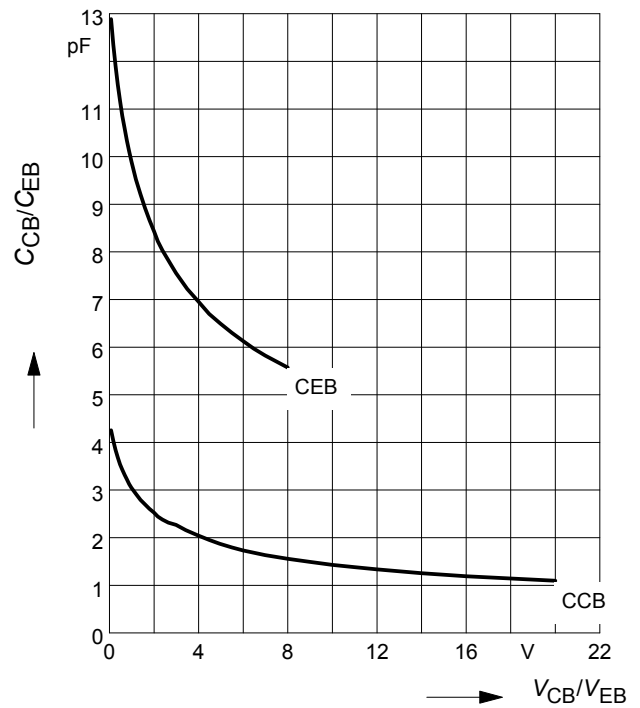

Total power dissipation $P_{tot} = f(T_S)$

BC847-BC850



Total power dissipation $P_{tot} = f(T_S)$

BC847BL3/BC848BL3



Total power dissipation $P_{tot} = f(T_S)$

BC847W-BC850W



Permissible Pulse Load

$P_{totmax}/P_{totDC} = f(t_p)$

BC847/W-BC850/W



Permissible Puls Load $R_{thJS} = f(t_p)$

BC847BL3, BC848BL3



Permissible Pulse Load

$P_{totmax}/P_{totDC} = f(t_p)$

BC847BL3, BC848BL3



Noise figure $F = f(V_{CE})$

$I_C = 0.2\text{mA}$, $R_S = 2\text{k}\Omega$, $f = 1\text{kHz}$

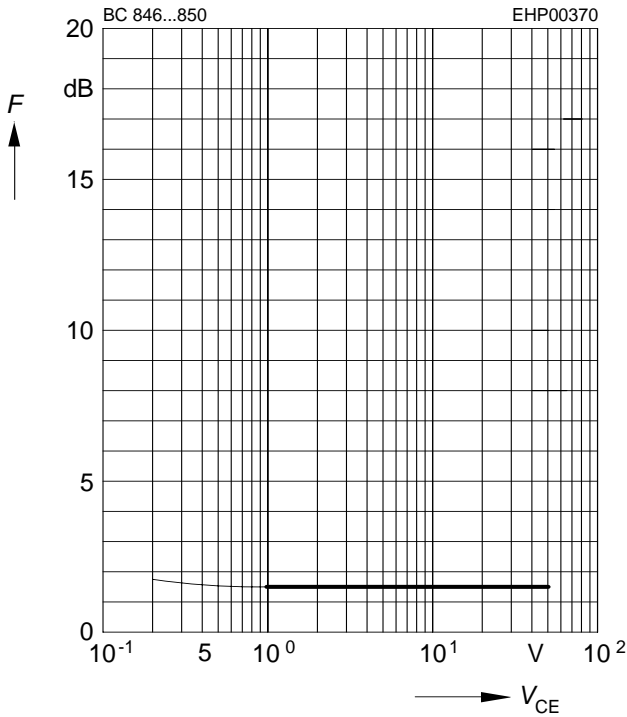

Noise figure $F = f(f)$

$I_C = 0.2\text{ mA}$, $V_{CE} = 5\text{V}$, $R_S = 2\text{ k}\Omega$



Noise figure $F = f(I_C)$

$V_{CE} = 5\text{V}$, $f = 120\text{Hz}$

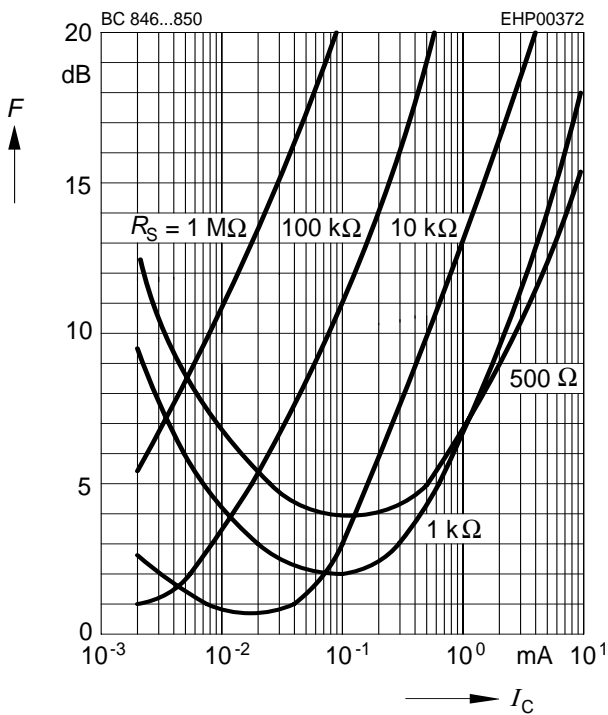

Noise figure $F = f(I_C)$

$V_{CE} = 5\text{V}$, $f = 1\text{kHz}$



Noise figure $F = f(I_C)$

$V_{CE} = 5V, f = 10kHz$

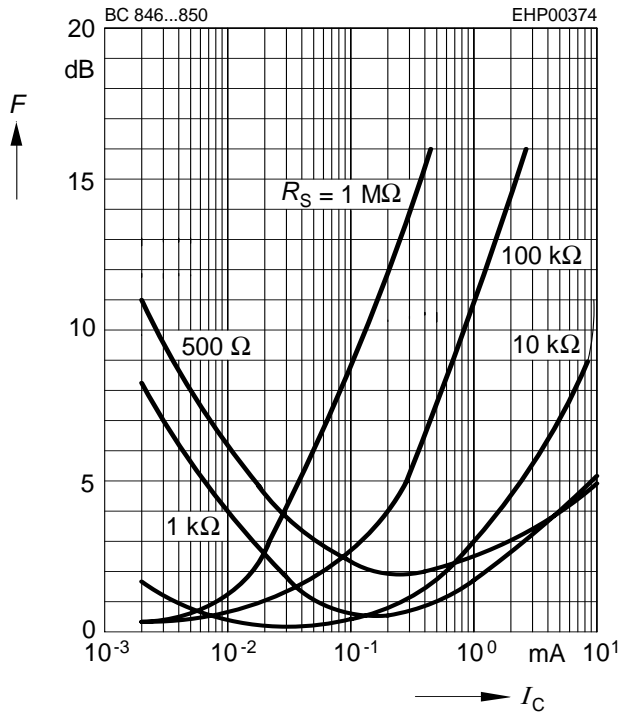

Package Outline

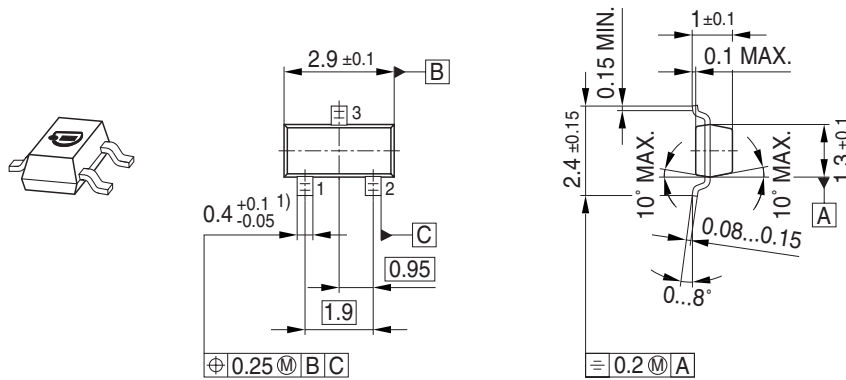

1) Lead width can be 0.6 max. in dambar area

Foot Print



Marking Layout (Example)



Standard Packing

Reel \varnothing 180 mm = 3.000 Pieces/Reel
 Reel \varnothing 330 mm = 10.000 Pieces/Reel



Package Outline



Foot Print



Marking Layout (Example)



Standard Packing

Reel \varnothing 180 mm = 3.000 Pieces/Reel
 Reel \varnothing 330 mm = 10.000 Pieces/Reel



Package Outline

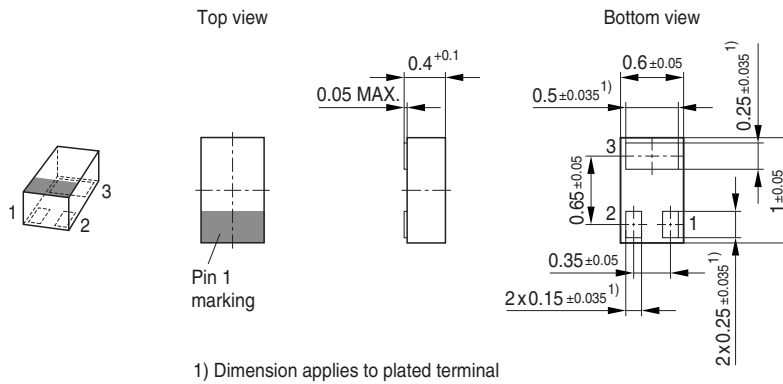

Foot Print

For board assembly information please refer to Infineon website "Packages"

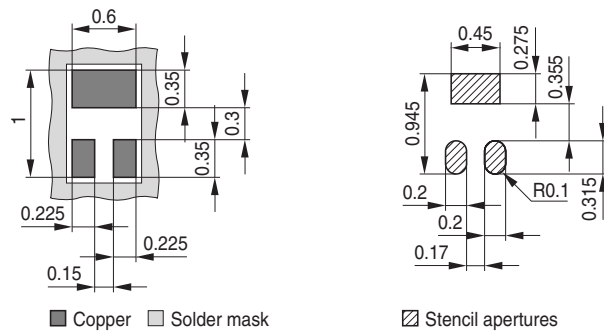

Marking Layout (Example)

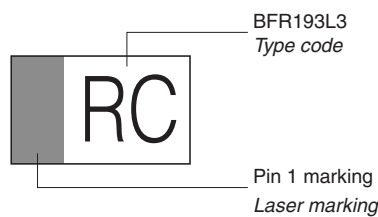

Standard Packing

Reel ø180 mm = 15.000 Pieces/Reel

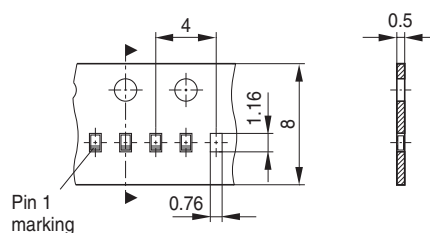

Edition 2009-11-16

**Published by
Infineon Technologies AG
81726 Munich, Germany**

**© 2009 Infineon Technologies AG
All Rights Reserved.**

Legal Disclaimer

The information given in this document shall in no event be regarded as a guarantee of conditions or characteristics. With respect to any examples or hints given herein, any typical values stated herein and/or any information regarding the application of the device, Infineon Technologies hereby disclaims any and all warranties and liabilities of any kind, including without limitation, warranties of non-infringement of intellectual property rights of any third party.

Information

For further information on technology, delivery terms and conditions and prices, please contact the nearest Infineon Technologies Office (www.infineon.com).

Warnings

Due to technical requirements, components may contain dangerous substances. For information on the types in question, please contact the nearest Infineon Technologies Office.

Infineon Technologies components may be used in life-support devices or systems only with the express written approval of Infineon Technologies, if a failure of such components can reasonably be expected to cause the failure of that life-support device or system or to affect the safety or effectiveness of that device or system. Life support devices or systems are intended to be implanted in the human body or to support and/or maintain and sustain and/or protect human life. If they fail, it is reasonable to assume that the health of the user or other persons may be endangered.

单击下面可查看定价，库存，交付和生命周期等信息

[>>Infineon Technologies\(英飞凌\)](#)

[>>点击查看相关商品](#)